

## A METHOD FOR SUPPORTING THE MULTI-DISCIPLINARY INCREMENTAL PRODUCT DEVELOPMENT

**Hannu Oja**

Tampere University of Technology  
Konecranes VLC corp.  
P.O.Box 666  
05801 Hyvinkää  
FINLAND  
E-mail: hannu.oja@konecranes.com

**Asko Riitahuhta**

Machine Design  
Tampere University of Technology  
P.O.Box 589  
33101 Tampere  
FINLAND  
E-mail: asko.riitahuhta@tut.fi

*Keywords: Product design, development, innovation*

### **Abstract**

Majority of product developments in industry are made to existing products e.g. improvements or adaptive designs. Different methods and tools for creativeness and idea generation have been presented widely in literature. However, many of these methods are context-free and do not include any specific means to direct the development of the technical system. The development and design processes are typically separated into technological disciplines, which may become a hindrance for understanding the integrated impacts and connections of a system. The objective of this study is to search and analyse successful innovative multi-discipline solutions and to recognise similar patterns in the development process. This paper presents a multi-discipline product model to support innovative solution finding.

### **1 Introduction**

The initiation of product development projects may take place by new technical innovation or by market demand. Majority of the product development projects in industry are made to existing products e.g. improvements or adaptive designs [Cooper1993]. This occurs especially among mature businesses, in which the real new innovations are rare. The survival of companies is depended on their capability to provide a better product performance (with improved characteristics or usability) and/or decreasing product costs. The primary effort of the companies to improve their position on the market is to maintain and strengthen their product portfolio through incremental product development.

Different methods and tools for creativeness and idea generation have been presented widely in literature. However, many of these methods are context-free and do not include any specific means to direct the development of the technical system, functions or product structure. The lack of specificity ignores the potential guidances for incremental, more feasible improvements.

The objective of this paper is to present a design approach for a tailored, complex system and to show how product improvements and innovations may impact within the design process. A multi-disciplinary approach to the design of modern machine systems is founded on the

information flow model and developed further by visualising the interactions between technical disciplines. A method for creating incrementally innovative solutions is generated on the basis of problem solving chain that has been recognised from similar patterns within product development projects. The principle of this method is visualised with a cross-reference interaction chart. Results are identified from a case study, in which new incremental innovative solutions have been developed by using the method created in this study.

## 2 Product conceptualisation and design process

The product development process, once the mission statement has been established, starts with conceptualising and developing possible solutions. Different methods may be used for decomposing the technical system into structures: transformation processes, functions, organs and parts [Ullrich&Eppinger1999], [Pahl&Beitz1996], [Hubka1988]. When the design process continues from abstract structures to more concrete ones the separation into technological disciplines may take place. In case of incremental development, the product and function structures already exist and, generally, the design process and documentation is strictly divided into technological disciplines: mechanical, electrical and control systems. This separation is a natural result of discipline-based product specifications and development teams. However, function structures may be directed towards the discipline separation already during the conceptualising stage. The aim of the mechatronics was to change the product development more multi-disciplinary [Reunanen1993]. The separation into technological domains may become a hindrance for understanding the integrated impacts and connections of a system.

### 2.1 Product specification and design requirements

A simplified presentation of design approach within adaptive design projects can be visualised as shown on Figure 1. Once the product concept and the technical solution are defined, the design process flows from upper level towards detailed design. The hierarchy levels are shown, for example, describing the flow of design requirements into details. On each level the design process follows a systematic methodology to find out an optimal solution, e.g. design conditions are reflected against design constraints. At this stage the design constraints cannot be changed: they are either based on standards (limit state), specifications (design margins), material properties (strength) or company practise (experience).

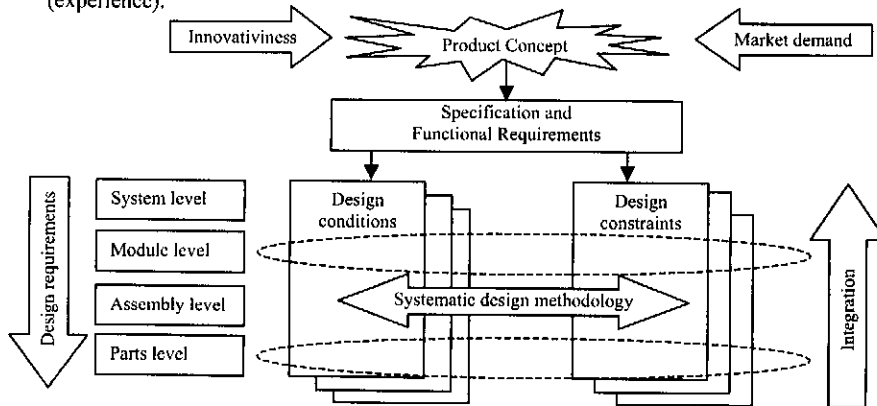

Figure 1. Typical adaptive design approach

It is claimed here that within this type of process, the solutions are directed to be developed discipline-dependent, because the design conditions and constraints are set already on specification level. Systematic design methodology may provide innovative solutions, but only within each design level.

## 2.2 Incremental innovation and product improvements

Product innovations or improvements may be realised by various forms. Different definitions may be found in literature for different types by their existence [Cooper1993], [Leifer, et al.2000]:

- *Radical innovation*: a totally new or new to application solution realised by new concept. These are not considered in this context
  - *Incremental innovation*: a significant improvement on product properties by variation
  - *DFx-methods*: an optimisation and/or integration of product components
  - *Continuous improvements*: an improvement on quality, manufacturing, refining of details
- The type of innovation has impacts to product, but also to stages of the design process. The relation and impact of the type of innovation or improvement to product design phases may be visualised as shown on Table 1.

**Table 1. Relation of product design activity and type of development**

	Incremental Innovation	DFx - methods	Continuous Improvements
Conceptual Design	▼		
Embodiment Design	▼	▼	
Detailed Design	▼	▼	▼

The product concepts are rather stable within the industry, which products have a long life cycle. As referred by various studies, the majority of product developments are the type of incremental innovations.

As product improvements are typically achieved by a systematic analysis of details, e.g. quality reports, cost breakdowns or DFx-methods, the creation of innovative product variations is not well supported by a systematic design approach. This may be a result of:

- Product concept seldom includes other than functional aspects of the product
- Functionality is often divided into technological disciplines
- Product characteristics and properties derived from customer needs (target specification) will follow during later stages of refining the specification.
- Product behaviour is expected to be automatically fulfilled by meeting the specified features of different disciplines

However, product behaviour and means for achieving them is a combination of different systems involved (disciplines: mechanics, electrics, control). Decomposing the functional requirements into design parameters may produce optimal design attributes, but it may ignore some critical interactions or impacts resulting from single-discipline optimisation aspects, like noise, vibrations etc. [Dong2001].

Methods for comprehensive product property definitions, describing product behaviour under operation, have been presented by means of abstraction hierarchy [Lind1999], House of Quality and Design Structure Matrix, but these methodologies do not provide adequate support for multi-discipline development approach.

It is presupposed here that the systematic design methodology supports finding optimal solutions, continuous improvements and re-engineering within one technical discipline, but it gives less support for finding innovative alternative solutions in multi-discipline systems. It is

also argued that the single-discipline approach reduces the possibility of finding new solutions.

### 3 Method for innovative incremental solution

The driving force for searching an applicable method is to recognize a behaviour aspect of the product. As described earlier and referred in various studies, modern machines consist of multi-discipline integrated systems, and the final product functionality and behaviour is the result of the systems interaction. If the product system is described and analysed independently by each discipline, the potential opportunities of behaviour improvement cannot be recognised.

The difference between incremental innovative solution and continuous improvements may be small and vary among businesses, but in this context the differentiation between these two has been defined as follows:

- *Continuous improvement* is the type of product detail modification, which is a result of more accurate calculation or simulation methods, decreasing the design constraints, improved manufacturing methods, better quality etc.
- *Incremental innovation* is the type of product variation, which is a result of changed design conditions, caused by the change of system behaviour and resulted a better system usability, performance or reduced cost.

Modern machines consist of multiple systems that interact and impact to each other. It is claimed here that the behaviour of the system is strongly depended on the integration of technological disciplines and it could not be optimally fulfilled by developing each technology independently. Operation of the machine is utilised through control system, having signal flow functions as described in Figure 2 [Lehman1985].

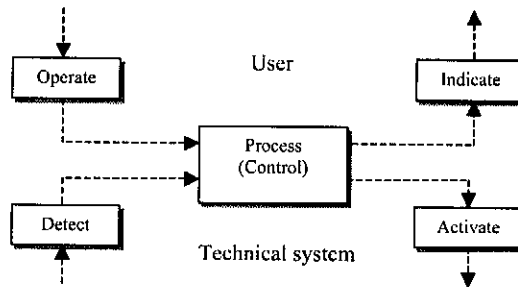
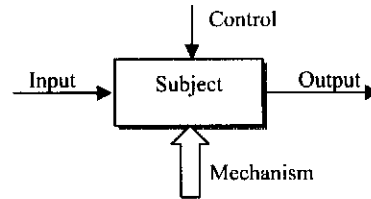

Figure 2. Basic signal flow functions

The predecessors of the modern PLCs (Programmable Logic Controller) were capable to perform automatic sequences and conditional jumps. The latter controllers are more computer type and capable to perform more complex functions and calculations created by structured languages and state diagrams. Thus the operational schematic of a modern machine as shown on Figure 2 has been early acknowledged, the typical way of generating the “Activate” sequences strictly follows the functional requirements and mechanical structure according to the product specification.

SADT system engineering method was developed on 60's in MIT and later developed for commercial use under name IDEF0. Within SADT, a (complex) system is viewed as a system

of interacting systems, in which, each has boundary, behaviour and substance. The interactions between systems can include concrete and abstract connections. The modelling scheme is presented by SA-boxes, which is shown on Figure 3.

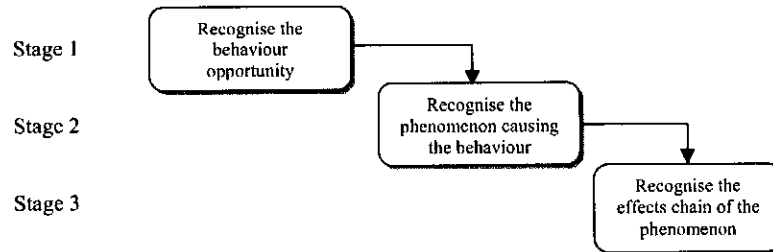

**Figure 3.** SA-box, under control, input is transformed into output by the mechanism

By SADT system description, the model focuses either on system activities or system things (data). These activities or things are presented with connected SA-boxes. The model is developed from one particular viewpoint and co-ordinated descriptions form sets of diagrams. Diagrams, (connected SA-boxes), are organised into a hierarchic structure, in which the top diagrams are most general and the bottom ones most detailed [Marca1988].

Having this introduction as a starting point for understanding the behaviour of the system, the development of the existing product may be approached by a different methodology. The primary target of the method is to capture an understanding of the design conditions and actively search alternative solutions to change design conditions, either by completing, interpreting or modifying the specification.

Once the system or sub-system has been selected as a target for development, either due to arisen problems or realised potential, the nature of the opportunity may be approached as shown on Figure 4.



**Figure 4.** Opportunity recognition chain

The typical behaviours at stage 1 are measures like vibration, noise, deflection, response time, stress temperature or cost. Occasionally these impacts are the results of optimisation described before. At stage 2 the “root causes” for the behaviour may be physical, like force, torque, mass, acceleration, speed, current or other component related like size range increments. The stage 3 provides the platform for searching the alternative solutions. At this stage the multi-discipline approach is mandatory, because the impact chain is defined. The exact mode of activation by control system followed by powered movement (typically electrical) of mechanics shall be described. These activation modes in each technical discipline are later identified as features. Accordingly the system behaviour “modes” shall be described to identify possible changes caused by alternative solutions in the impact chain. A

practical tool for impact chain definition is SADT modelling and a tool for change identification is QFD.

### 3.1 Product properties and behaviour

The product properties and behaviour of PLC driven machines may be described as shown on Figure 5. The product properties, which may be visually identified, are the results of multi-discipline impact chain within the product.

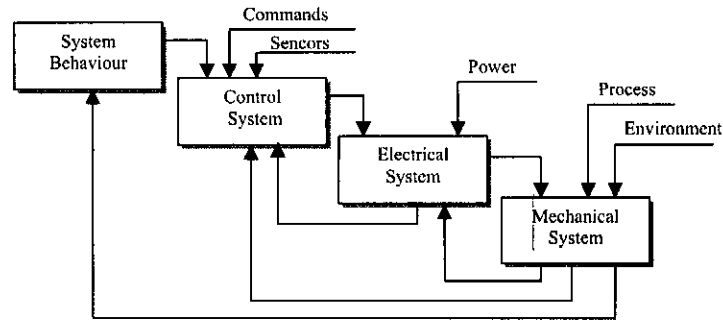

Figure 5. Product system behaviour impact chain

The product specification collects the customer requirements, e.g. functional requirements with complements of product properties based on customer needs. These requirements may be presented in various forms, typically a verbal list. As the requirements present the customer approach, they need to be translated into technical attributes. From the design point of view, the system behaviour is the result of much wider interaction of the product systems than just the technical attributes.

Typical industrial design process is done by separated professional disciplines. This may be a result of functional organisations, product specifications or unmanaged distributed design activities. The separation of professional disciplines generally leads to situation, where the functional requirements and characteristics of the product are mainly defined by the mechanical system. Product or chief engineer generally manages the system co-ordination, but depending on the complexity of the system, the level of details, which results the system behaviour, cannot be adequately controlled.

### 3.2 Impact mapping for innovative solutions

The problem of generating innovative solutions is versatile. Various problem solving and creative team working techniques (e.g. brainstorming, method 635, etc.) exist to support innovative environment. However, common with these tools is that they all are context-free and require a specific preparation and control from the process leader.

The specific nature of long-lasting products is that applied product concepts have long evolution history with build-in optimisation, e.g. re-shaping the design criteria. Generation of innovative solutions needs a new approach for the systems as whole to provide understanding of interactions and impacts. As the product concepts are old and proven to purpose, the means for development require a change of design conditions to enable product variation or, in the best case, a new concept. The presented approach may provide a fruitful advice for finding means to change system behaviour as a result of changing the design conditions.

The presented method follows the problem identification chain as shown on Figure 4 to identify problematic system behaviour items. Further on, the influences and impacts are analysed against the three main technical disciplines as shown on Figure 6.

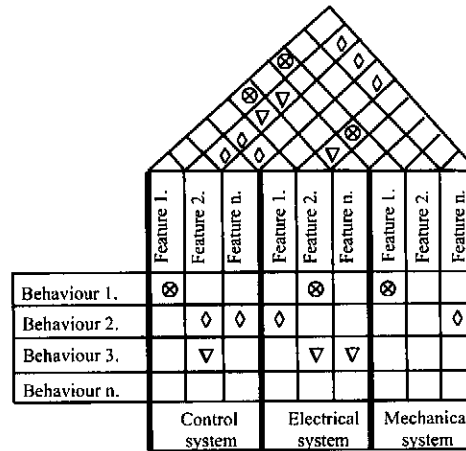

Figure 6. Multi-discipline interaction mapping

Mapping within each discipline introduces the discipline-centred view for improvements. Naturally, the evaluations for each discipline require in-depth knowledge of particular features and realisation. This view is further developed by mapping between the disciplines and evaluating the impact chain. Visualised interactions provide considerable targets and means to change the design conditions.

The impact mapping is presented with a graph similar to QFD-method, in which the system behaviour items on the left hand column present the evaluation stage 1 on Figure 4, "Problematic or limiting behaviour in the system". These may be, for example, like: vibration, deflection or current. The features listed on the upper row of each discipline describe that particular phenomenon or feature which has direct influence on behaviour. Each row (e.g. each behaviour) shall have indication at least two disciplines to provide interaction at triangle on top of the graph. Recognised interactions lead to find possibilities to modify or change the design conditions. The detailed SADT-graph of a particular interaction chain may be constructed for the more detailed analysis to specify a change of design conditions and for the innovative solution finding, e.g. change of control sequence, change of mechanical transmission etc.

#### 4 A case study and its results

A brief example of the above-described method is presented in this chapter.

An opportunity of structural behaviour of a large ship-to-shore crane [Figure 7] was recognised. The acceleration and deceleration movement of the gantry along the rails on quay generates a horizontal force impulse. The high inertia of the structure responses the acceleration and deceleration with a large transform (deflection) at boom level. The impulse generates a natural vibration of the structure, whose amplitude is relative to acceleration. As the acceleration time is much longer than the natural frequency of the structure, the accelerative movement amplifies the structural deflection. This vibration is very harmful for the crane operation and reduces significantly the performance.

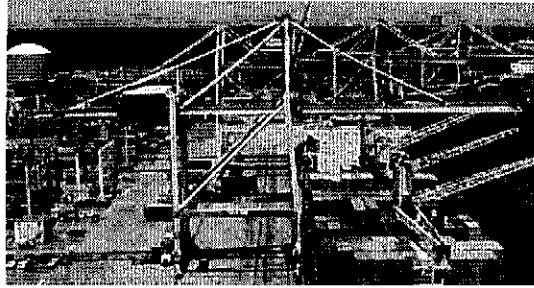

Figure 7. Ship-to-shore container crane

The opportunity recognition according to Figure 4 is as follows:

*Stage 1:* The behaviour opportunity is a large horizontal structural deflection that leads to a product performance reduction.

*Stage 2:* The deflection is caused by an acceleration/deceleration force impulse that is amplified during the accelerative motion.

*Stage 3:* The control system commands the motor torque to be generated, open the brakes, start acceleration with predetermined linear ramp (acceleration time specified on product specification).

As the acceleration time cannot be changed (customer specified constraint), an obvious single discipline (mechanical) approach will result a development task to increase structural rigidity. However, this will result either an increased structural weight or more complicated and unfavourable structural sections (like lattice).

A multi-discipline interaction mapping is shown on Figure 8.

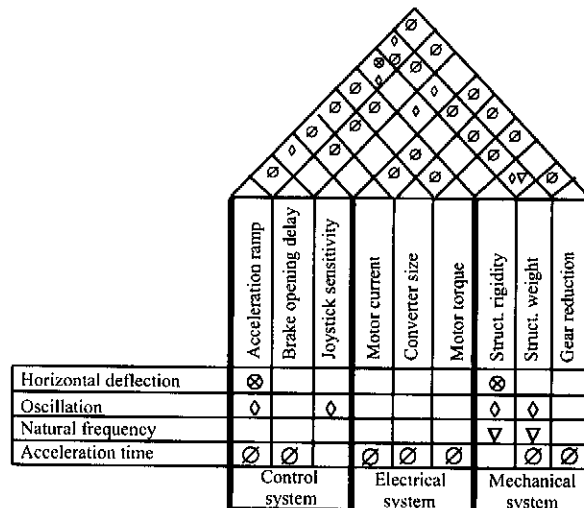

Figure 8. Interaction mapping, case study

The multi-discipline interactions are shown on Figure 8. It is visible that mapping between disciplines generates various alternative opportunities for development. As a result of the case study, the final developed solution was based on a new acceleration ramp sequence, in which



the acceleration is changed according to the amplitude of the natural frequency of the structure. The oscillation is dampened with modified ramp during the acceleration and deceleration movement and results smooth and convenient operation without any reinforcements to the structure.

## 5 Conclusions

The study was made in the leading globally operating crane manufacturer KCI Konecranes and especially in its Very Large Cranes business unit. The company designs and manufactures investment products in a mature business environment.

The method has been generated on the basis of recognising similar patterns within product development projects, which have resulted incremental innovative solutions. In each case the inventions are included in larger product sub-systems, but having interactions between three technological disciplines. Common to all new solutions is that the design conditions of the systems have been changed and direct improvements on product behaviour, performance, usability or cost have been achieved. The method has a strong connection with SADT- and QFD-methods, but it is modified in a new way to support innovative solution finding.

The method has been applied in several cases, in which the "root cause" for the system is dynamic; e.g. accelerating motion, oscillation or inertia is involved. The problematic behaviour of the system has been identified or visualised by vibration, deflection, power currency or functional delay. Multi-discipline modelling of the impact chain has significantly increased the shared understanding of the system behaviour between designers in different professional disciplines. Modelling has supported to generate new product variations (incremental innovations) by means of new software algorithms into the control system and new mechanical solutions to decrease torque requirements during the activation of movements.

Although the level of inventiveness of the above-presented case may be difficult to assess, it should be evaluated within the business and application environment. In that respect, the generated innovations may present different, new to application solutions and, as the consequence they have created such impacts as described for incremental innovation earlier in this paper.

## References

- Dong, Q., et al., "Designing a requirement driven product development process", *Proceedings of the DETC 2001, Pittsburgh 2001*
- Whitney, D., et al., "Introducing knowledge-based engineering into an interconnected product development process", *Proceedings of the 1999 ASME Design Engineering Technical Conference, Las Vegas 1999*
- Lind, M., "Making sense of the abstraction hierarchy", *Proceedings of the CSAPC '99, Villeneuve d'Ascq, 1999*
- Whitman, L., et al., "Structured models and dynamic systems analysis: the integration of the IDEF0/IDEF03 modelling methods and discrete event simulation", *Proceedings of the 1997 Winter Simulation Conference, Coronado 1997*
- Reunanen, M., "Systematic safety consideration in product design", *Doctoral Thesis, Tampere University of Technology, 1993*
- Hubka, V. et al. "Theory of Technical Systems", Springer-Verlag, Berlin 1988
- Pahl, G and Beitz, W., "Engineering Design" 2<sup>nd</sup> ed., Springer-Verlag, London 1996
- Ulrich, T., Eppinger, S., "Product Design and Development", McGraw-Hill/Irwin, New York 1999
- Pugh, S., "Creating Innovative Products Using Total Design", Prentice Hall, 1996
- Leifer, R. et al., "Radical Innovation: How Mature Companies Can Outsmart Upstarts", Harvard Business School Press, 2000
- Marca, D., "Structured Analysis and Design Technique", McGraw-Hill 1988
- Cooper, J., "Winning at New Products: Accelerating the Process from Idea to Launch", Addison-Wesley Publishing 1993